

iRepeater

About

The iRepeater is a commercial grade cellular amplifier that works for all mobile operators. When connected to the Stelladoradus cloud dashboard, you can remotely manage, monitor, and adjust the amplifier, as well as receive real-time measurements of signal power, signal gain, plus other control metrics for each band.

The 4 indoor antennas allow you to amplify the cellular signal into 4 separate areas inside your building/ship.

iRepeater can be installed with iLineAmps in a modular system to provide coverage in large multi-story, multi-zone buildings.



Wallmount

Rackmount

Features:

- LCD Touch Display - Enhanced user experience.
- 4 indoor antennas - 4 individual coverage areas.⁴
- Cloud Monitoring
- Boosts all operators - Works with all phones and devices.
- Boosts All networks³ 2G/3G/4G/5G.
- Completely network safe.
- Conforms to E.T.S.I specifications.

Model	Bands	Ports	PSU	Weight	Dims cm ⁵	Antennas
iR4-LGDW	B20, B8, B1, B3	2	12V,5A	1.6kg	27X29X3.8	2
iR5-EMEA	B20, B8, B1, B3, B7	4	12V,5A	2kg	43X30X3.8	4
iR6-EMEA	B28, B20, B8, B3, B1, B7	4	12V,7A	2.1kg	43X30X3.8	4
iR5-US*	B28, B4, B5, B25, B7	4	12V,5A	2kg	43X30X3.8	4

*Caribbean only

Standard kit includes:

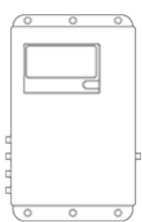

iRepeater



¹External antenna

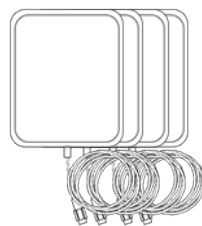

²Internal antennas

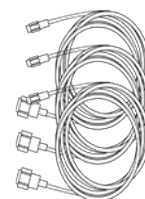

²Internal cables SD400



External 15m cable SD400

¹Omni for ships, Yagi for buildings.

²Custom antennas and custom cable lengths supplied.

³Dependent on operator/ location.

⁴iR4 has 2 ports/ antennas only.

⁵Dimensions for rackmount are 400X89X430

Check models above for your frequencies

EU Bands	B28	B20	B8	B3	B1	B7
Downlink	758-788	791-821	925-960	1805-1880	2110-2170	2620-2690
Uplink	703-733	832-862	880-915	1710-1785	1920-1980	2500-2570
US Bands <small>Caribbean</small>	B28	B4	B5	B25	B7	
Downlink	758-788	869-894	2110-2155	1930-1990	2620-2690	
Uplink	703-733	824-849	1700-1755	1850-1915	2500-2570	

Amplifier Specs

Coverage	(1000m ² per antenna X 4) = ~10 rooms
Gain	Uplink Gp: 60dB Downlink Gp> 60dB
Pass band ripple	<4dB
I/O impedance	50 ohm/SMA female connector
Max up/down signal strength	20dBm / 10dBm
Ambient Temperature	-30°C to +70°C
Power supply input	110 - 240V AC
Oscillation Control	Automatic
AGC Level Control:	Automatic ¹
Uplink Switch On	Yes ²
AGC Range	30dB
Surge protection	SMA connectors DC grounded, 12V DC port MOV protected

Antennas

	Indoor Panel	Outdoor Yagi
Nominal Gain	6.4dBi / 9.4dBi	10dBi
3dB beam Pattern	60° x 60°	60° x 50°
Bandwidth	700MHz - 2700MHz	700MHz - 2700MHz
VSWR	<1.4	<1.5
Front to Back Ratio	> 20dB	> 20dB
Polarization	Vertical	Vertical
Power Rating	50W	50W
Impedance	50-OHM	50-OHM
Termination	SMA male	N-Female
Cross Pol. Discrimination	-20dB	-20dB
Dimensions	210 x 180 x 43mm	442 x 205 x 62mm
Weight	0.68kg	1.2kg
Wind velocity	126km/hr	140km/hr
Working temperature	-40°C to +65°C	-40°C to +65°C

¹Automatically adjusts during installation. Thereafter, automatically adjusts for seasonal variation in pathloss between the base station and the outdoor antenna.

²The uplink amplifiers switch off when the repeater is not in use. This reduces the uplink noise to almost zero. When the repeater is in use (phone call or data session), the uplink amplifiers switch on for the duration of the call/ data session only.

Note: Specifications subject to change without notice.

Install diagram

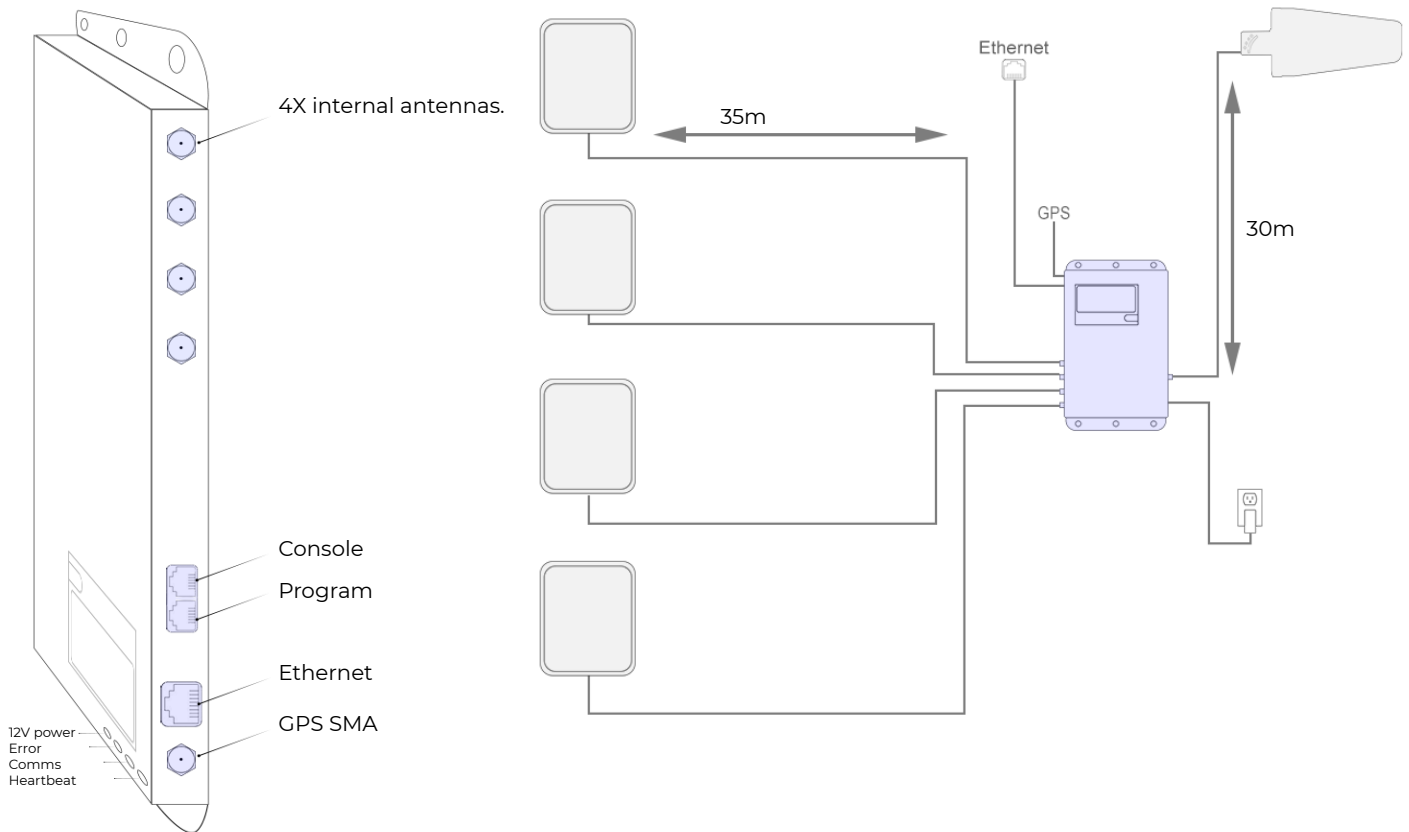

Modular system

For larger buildings, you can extend your system with iLineAmps.

In the example below, we are using 4 iLineAmps after the iRepeater to extend the signal deep into the building, giving us a total of 16 internal antennas.

This modular system can be extended up to 100 iLineAmps, offering coverage for even the largest multi-story building or mega ship.

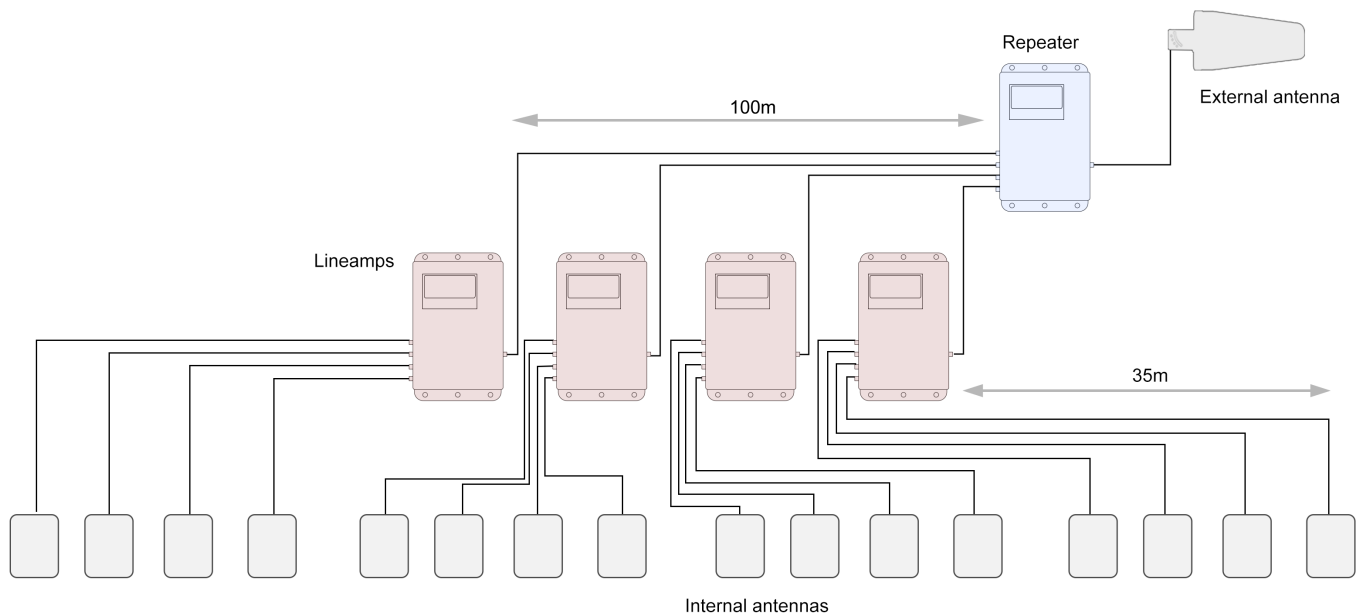

Main screen:

The green dots represent the downlink signal power.

The blue dot means that the band is switched on. This will happen when a call or data session is initiated. Once the call or data session is over, the band switches off and the blue dot also switches off.

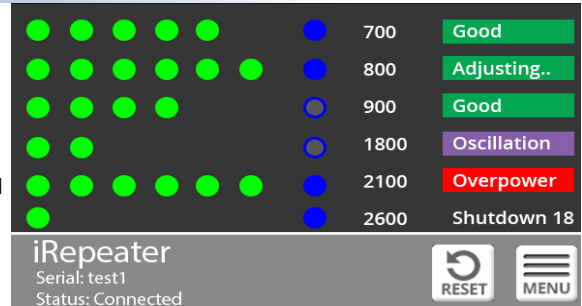

Good	Band has no problems.
Adjusting	Band is optimizing itself. This usually happens only once at boot up and only if there is a lot of down link power.
Overpower	There is a very strong outdoor signal. There is no need to do anything in this case as the repeater will optimize itself to deal with this.
Shutdown	There is too much signal power outside and the repeater is shutting down the band to protect the network.
Oscillation	Interference between the indoor and outdoor antennas. You should separate these antennas from each other to avoid oscillation. A separation of at least one solid block wall is recommended.

Decibel (dB) page:

The dB page shows the raw data coming from the amplifier. These dB values are very accurate.

Here we can see how the AGC (Automatic Gain Control) works on both uplink and downlink, and also how the amplifier manages oscillations.

Frequency (MHz)	700	800	900	1800	2100	2600
Power up (dBm)	-15	-15	-15	-15	-15	-15
Power dn (dBm)	-30	-30	-30	12	-30	-30
Phone up (dB)	5	5	5	5	5	5
Temp up/dn (dB)	0	0	0	0	0	0
Clamp (dB)	0	0	0	0	0	0
mgain (dB)			0	0	0	0
Max Osc (dB)	0	0	0	0	0	0
Total Loss dn	0	0	0	3	0	0

Power Up	Uplink power received by the repeater. (Power emitted by your phone)
Power dn	Downlink power received by the repeater. (from the base station)
Phone up	Uplink AGC - for phones passing nearby internal antennas, or just high power devices. Controls spikes in the uplink signal.
Temp up/dn	Uplink and downlink AGC. This controls the uplink and downlink gain at the same time, for when the base station downlink signal is too strong.
Clamp	Extra attenuation added for when there is an oscillation or high sustained DL power. This ensures any oscillation is completely removed.
mgain:	This is the manual gain. You can add your own attenuation to any band. Sometimes this is necessary for when there is too much power on any one band.
Max Osc:	This value is a permanent reduction to the gain of the amplifier, due to an oscillation.*
Total loss:	This is a sum of the temp up/dn + clamp + mgain + max osc. This value can be entered into the stellacontrol floorplan tool to help you to design your repeater systems.

Other LCD features

Pin Access	The default PIN code is 888888. This can be changed at a later stage on stellacontrol.com
Band On/Off	Turn any band on or off.
Band attenuation	Add up to 15dB of attenuation to any band.
Internal location	Here you can type a note about the amplifier. This note is sent and displayed on the stellacontrol Inventory page. An example note would be the internal location of the amplifier.

*Every 24 hours these oscillation reductions are cleared.